

ProLED-2X-SLIM

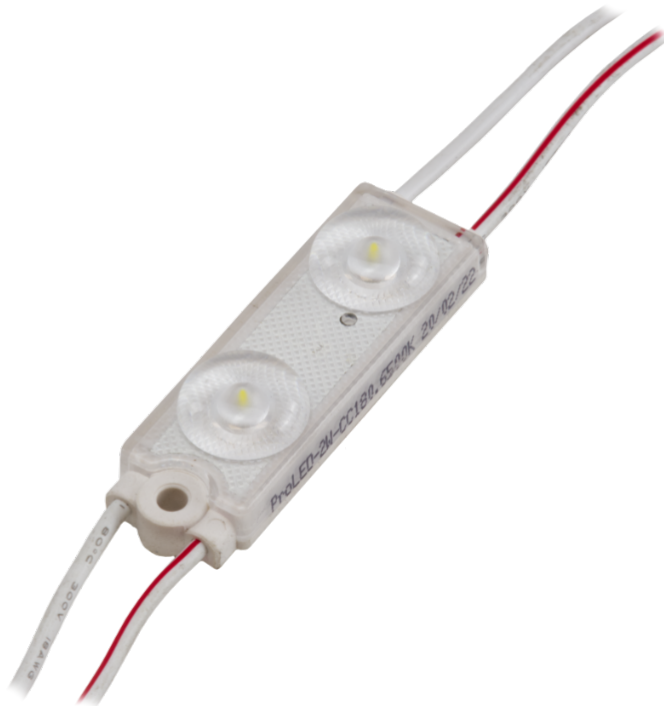

5-15 cm

3D letters, lightboxes



- luminous efficacy 170 lm/W
- premium quality
- energy-efficient
- for indoor and outdoor use
- 20 pcs in chain

DIMENSIONS

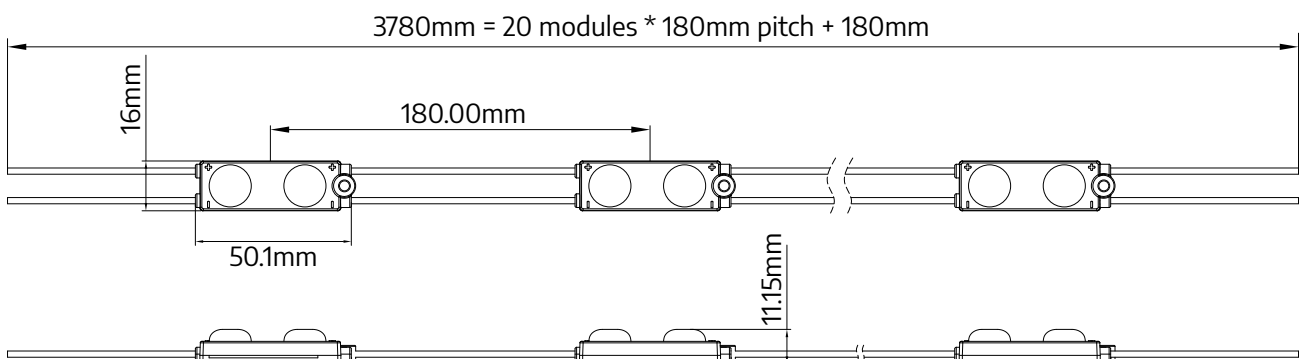

TECHNICAL SPECIFICATION

Parameter	Value
Rated voltage	12 V DC
Power consumption per module	0,72 W
Chain power consumption	14,4 W
Current consumption per module	60 mA
LED diodes	LumiLEDS - 2835
Quantity of LEDs	2
Light color	X = WW - warm white (3000K) X = NW - neutral white (4000K) X = W - white (7000K) X = CW - cold white (10000K)
Flux	116 lm (WW, NW, CW), 122 lm (W)
Flux density	161 lm/W (WW, NW, CW), 170 lm/W (W)
Color rendering index CRI	≥80 (on request ≥90, ≥95)
Beam angle	175°
Current stabilization	No
Dimming	Yes
Module dimensions (L × W × H)	50 × 16 × 11 mm
Cable length	130 mm
Number of modules in 1 m	5,5
Box weight	17 kg
Montage	Adhesive tape / mounting screw
Lifetime	L70B50 > 50000h
Working temperature	-25°C ... +60°C
IP protection	IP67
Warranty	7 years

ProLED-2X-SLIM



CONNECTION DIAGRAM

One-side power input



Maximum number of modules 20 pcs

Two-side power input



Maximum number of modules 40 pcs

It is acceptable to connect multiple chains in parallel, as long as the power supply provides sufficient power.

BEAM ANGLE

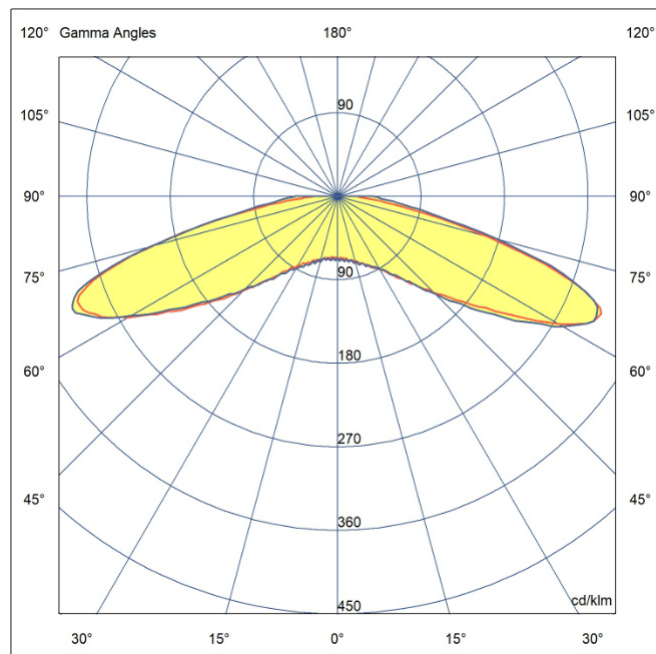

LIGHT COLOR / CCT

Abbreviation	Light color	CCT
WW	warm white	~3000K
NW	neutral white	~4000K
W	white	~7000K
CW	cold white	~10000K

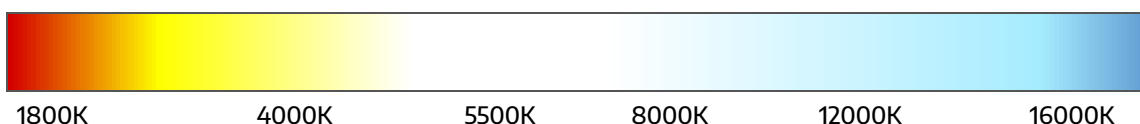

ProLED-2X-SLIM



APPLICATION

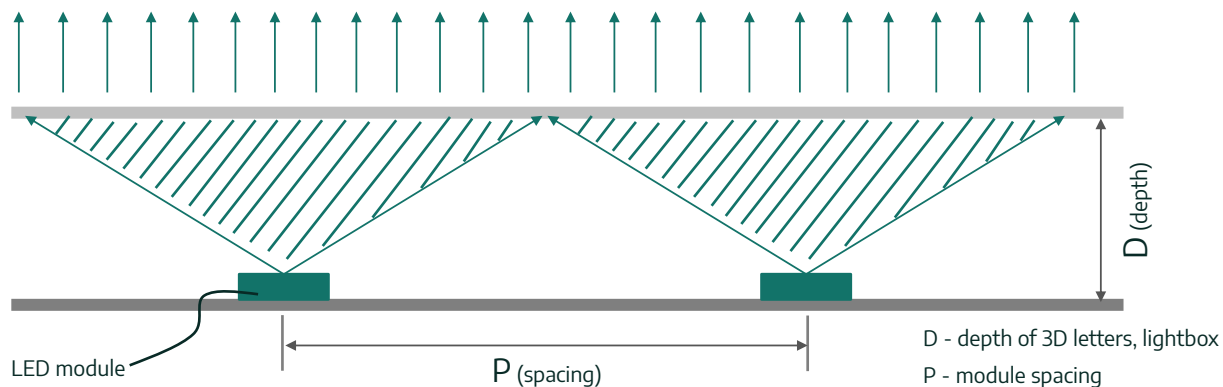

$$\text{optical performance proportion} = \frac{D}{P} = 1:3$$

Overall micro lens design can improve the lens uniformity performance.

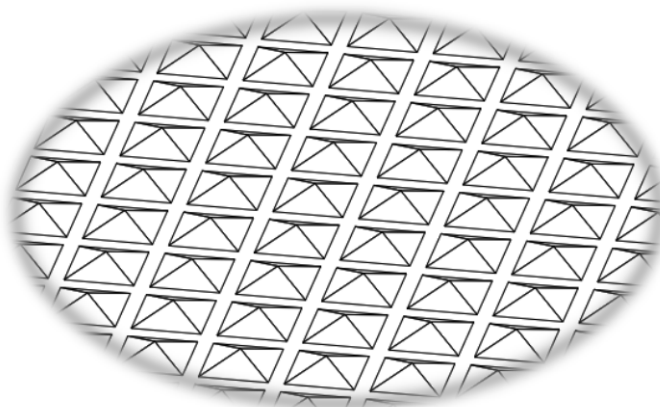

PACKING

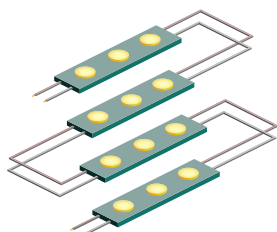

Chain
20 pcs



Bag
100 pcs

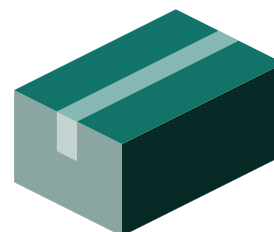

Box
1600 pcs